

**437**

0.251 Kg/m

**FİTİLLİ U**

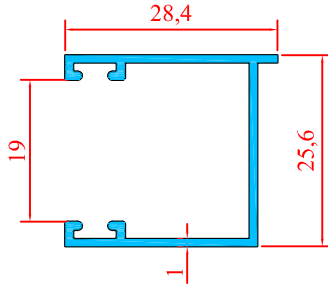

**1133**

0.130 Kg/m

**DAR U**

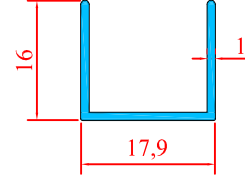

**512**

0.336 Kg/m

**ALT PARÇA**

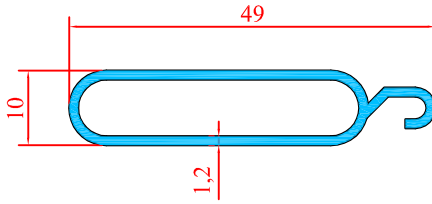

**1123**

0.347 Kg/m

**PANJUR**

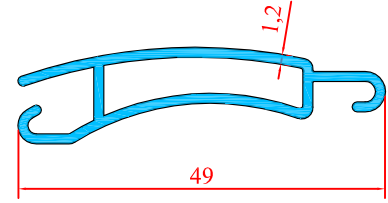

**1250**

0.692 Kg/m

**PANJUR**

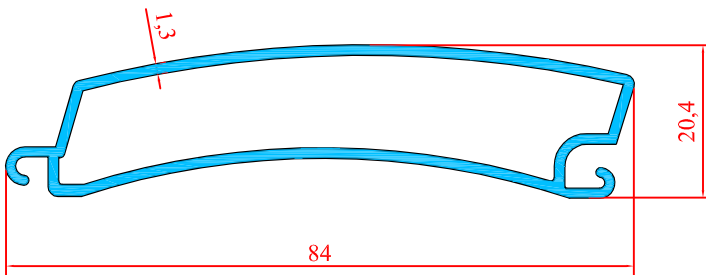

**1137**

0.294 Kg/m

**FİTİLLİ ALT PARÇA**

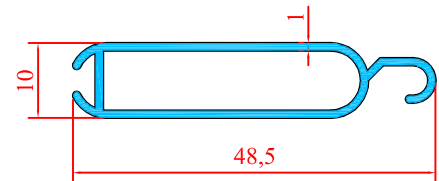

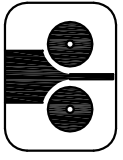

**1292**  
0.880 Kg/m  
**KEPENK PANJUR**

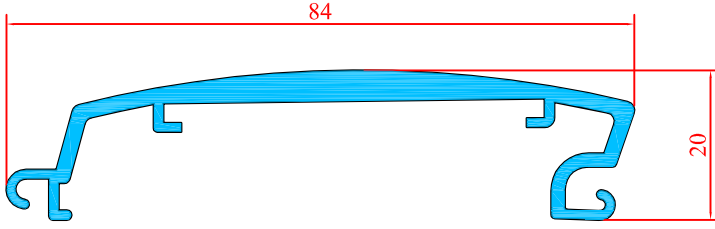

**510**  
0.232 Kg/m

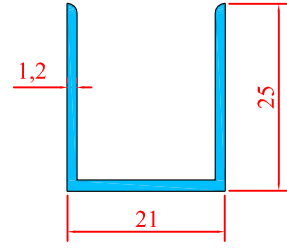

**1262**  
0.787 Kg/m  
**KEPENK RAY**

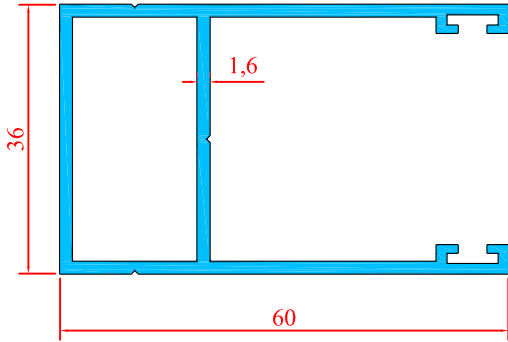

**511**  
0.185 Kg/m

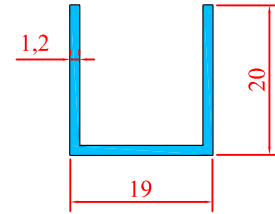

**1102**  
0.300 Kg/m

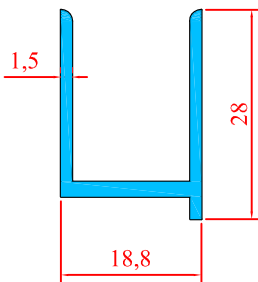

**1102 - A**  
0.234 Kg/m

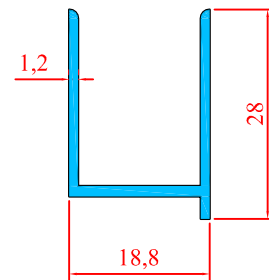

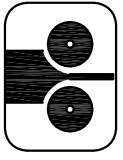

**1234**  
0.192 Kg/m  
**MİNİ SİNEKLİK**

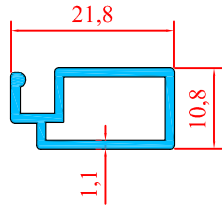

**1274**  
0.233 Kg/m  
**SİNEKLİK**

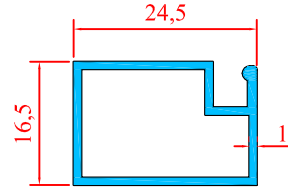

**1296**  
0.443 Kg/m  
**KAPI SİNEKLİK**

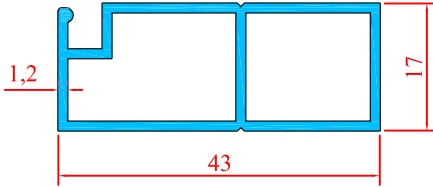

**1699**  
0.425 Kg/m  
**ÇITASIZ SÜRME SİNEKLİK**

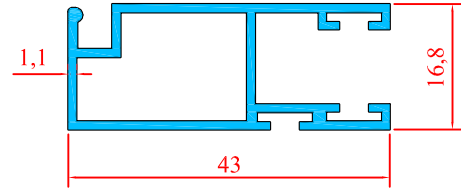

**2120**  
0.652 Kg/m  
**ÇITALI SİNEKLİK KANAT**

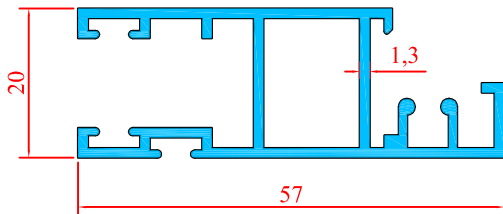

**2129**  
0.268 Kg/m

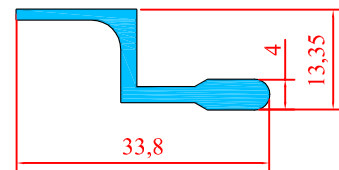

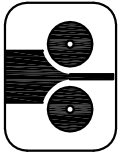

**1697**  
0.300 Kg/m  
2,5 LUK RAY

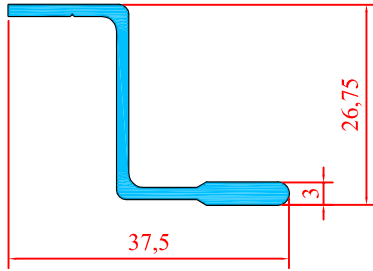

**1698**  
0.326 Kg/m

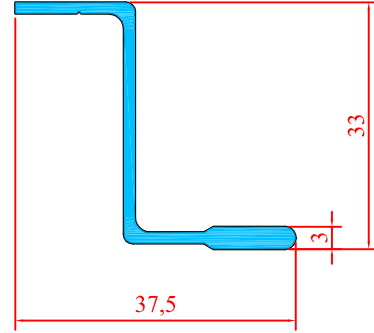

**3702**  
0.313 Kg/m  
3 LÜK RAY

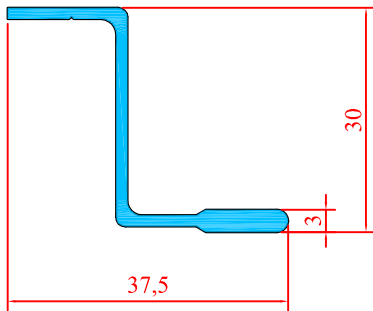

**2121**  
0.161 Kg/m  
ÇITA

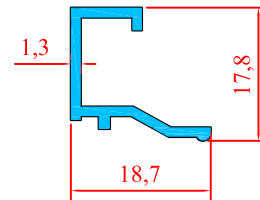

**1100**  
0.726 Kg/m

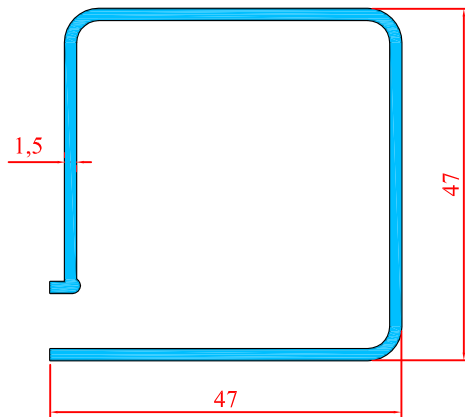

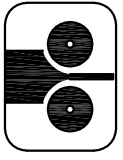

**3285**  
0.345 Kg/m

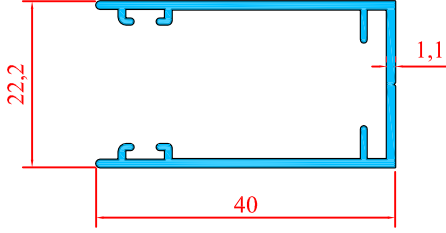

**3286**  
0.252 Kg/m

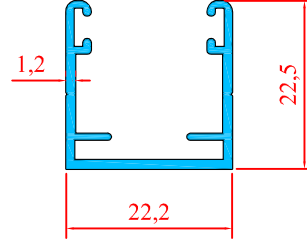

**3287**  
0.223 Kg/m

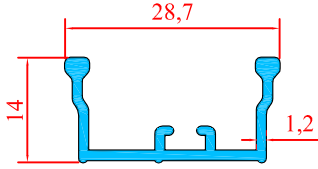

**3288**  
0.600 Kg/m  
**SİNEKLİK TÜL**

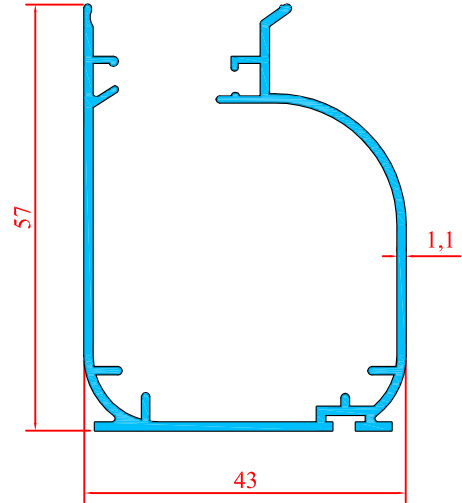

**3289**  
0.380 Kg/m

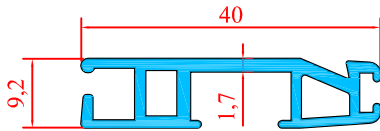

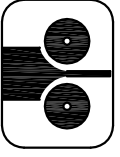

**3699**

0.454 Kg/m

**SİNEKLİK KANAT**

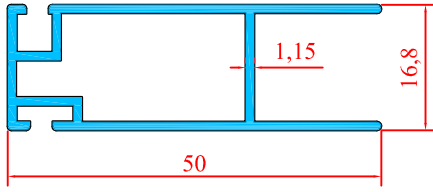

**3700**

0.525 Kg/m

**SİNEKLİK KASA**

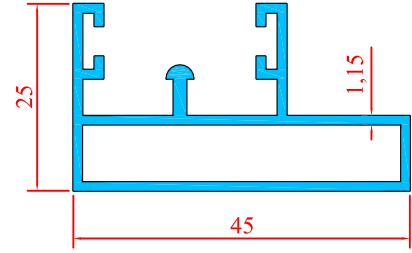

**3703**

0.530 Kg/m

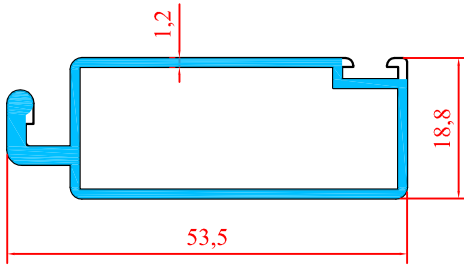

**3704**

0.315 Kg/m

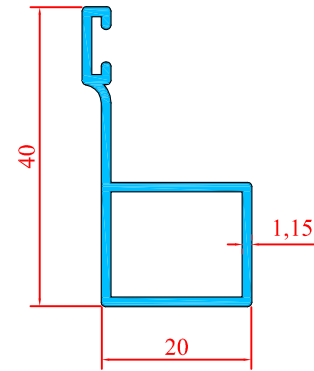

**3705**

0.452 Kg/m

