

**1400**

0.290 Kg/m

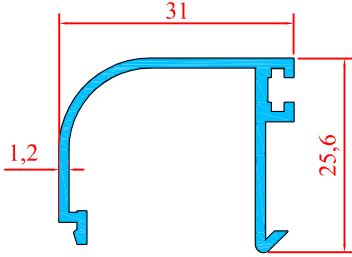

**1400 D**

0.307 Kg/m

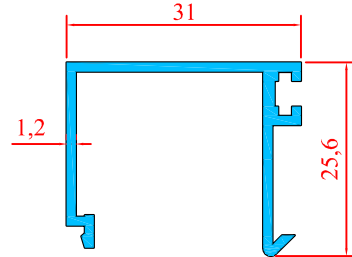

**1401**

0.268 Kg/m

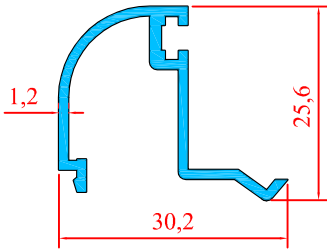

**1422**

0.280 Kg/m

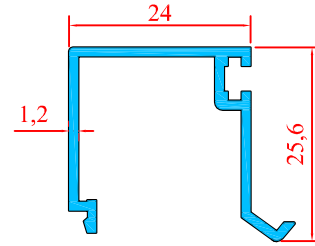

**1403**

0.937 Kg/m

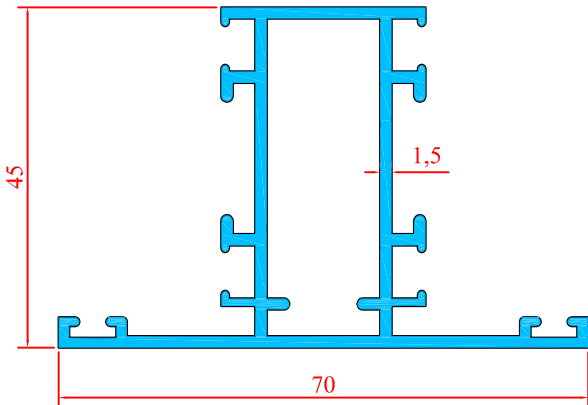

**1402**

1.028 Kg/m

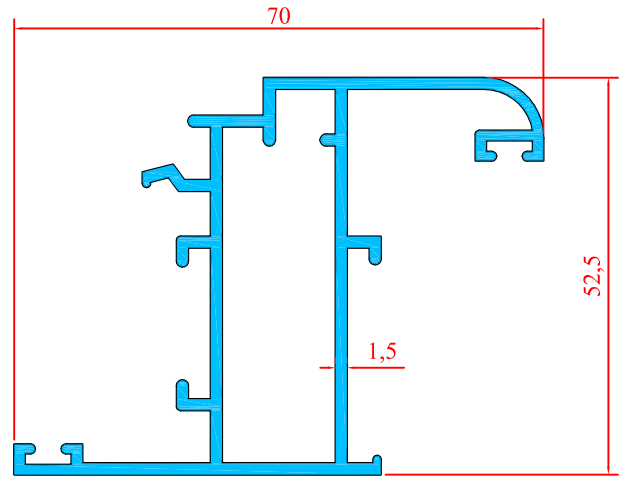

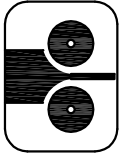

1404

0.828 Kg/m

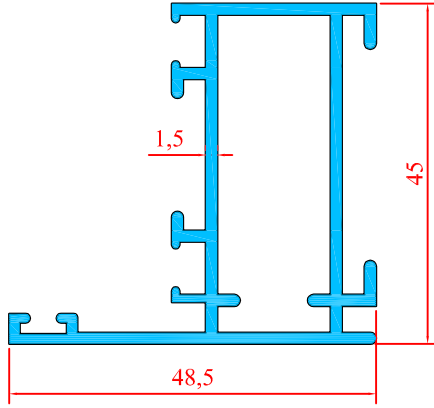

1405

1.167 Kg/m

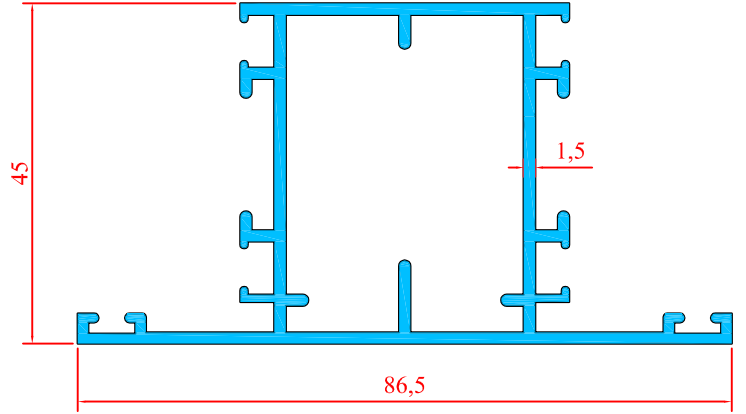

1406

1.228 Kg/m

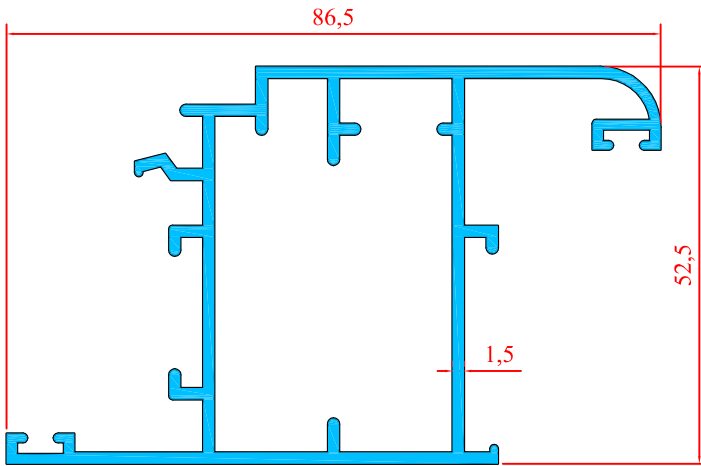

1407

0.995 Kg/m

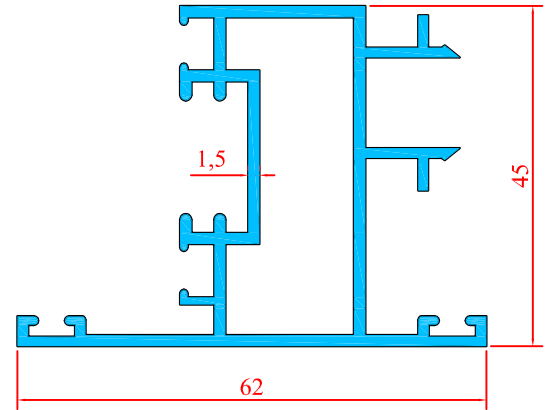

1408

0.759 Kg/m

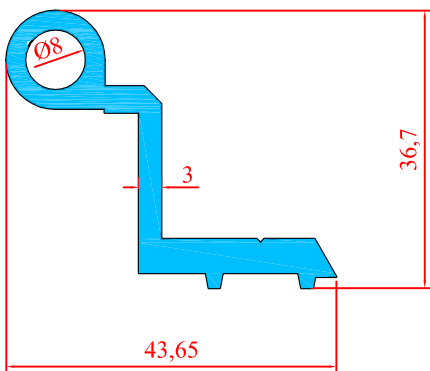

1409

0.785 Kg/m

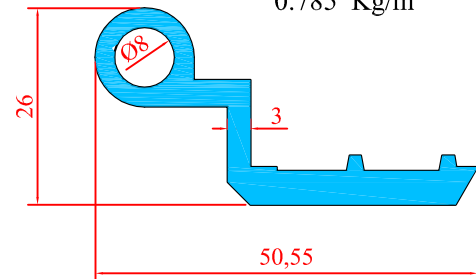

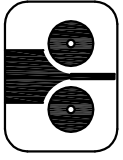

1423

0.975 Kg/m

TEK KULAK GENİŞ KASA

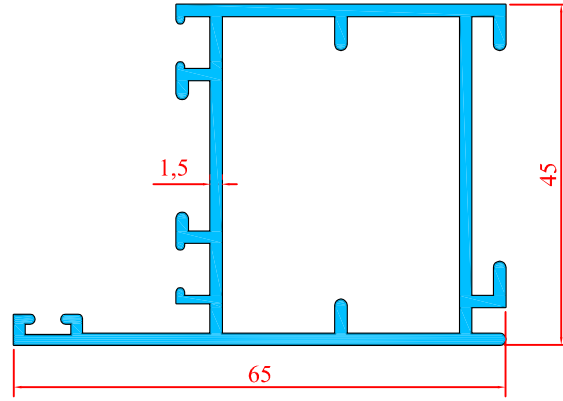

1424

1.433 Kg/m

ETEK

